

# AESCULAP® Acculan 4

LOOK. FEEL. EXPERIENCE.

Acculan 4 the battery-operated power system for orthopaedics, traumatology, cardiothoracic surgery and dermatology

- Powerful
- Longevity – Exclusion of battery and electronic control from sterilization process
- Easy handling – Titanium housing allows mechanical alkaline reprocessing



# AESFULAP® Acculan 4

## DRILL & ATTACHMENTS

**GA330**

**GB495R**

### Acculan 4 DRILL AND REAMER

250 W; ↻ ↻; ⚙️ 4.0 mm;  
207 x 121 x 55 mm; ⚖️ 1,250 g

consisting parts:

GA678 sterile funnel

GA672207 K-wire protection sleeve

GA672211 rinsing adaptor

GB600840 Sterilit spray adaptor

Acculan

Lid GA675 and NiMH battery GA676 to be ordered separately.

Measurements and weight are including battery and lid.



**GB620R**

**GB496R**

### Acculan 4 DRILL ATTACHMENT

with Jacobs chuck keyless 0.5 - 7.4 mm

0 - 1,000 rpm; 5.0 Nm; ⚙️ 4.0 mm;  
133 x 35 mm; ⚖️ 397 g



**GB621R**

**GB496R**

### Acculan 4 DRILL ATTACHMENT

with Jacobs chuck 0.5 - 7.4 mm

0 - 1,000 rpm; 5.0 Nm; ⚙️ 4.0 mm;  
118 x 35 mm; ⚖️ 300 g

consisting parts:

key GA031R



**GB623R**

**GB496R**

### Acculan 4 DRILL ATTACHMENT

with small AO chuck

0 - 1,250 rpm; 4.0 Nm; ⚙️ 2.8 mm;  
90 x 35 mm; ⚖️ 210 g





## ATTACHMENTS

**GB639R**

**GB496R**

### Acculan 4 DRILL ATTACHMENT

with Jacobs chuck 0.5 - 4.0 mm

0 - 1,250 rpm; 4.0 Nm;  4.0 mm;  
105 x 35 mm;  243 g

consisting parts:  
key GA062R



**GB645R**

**GB496R**

### Acculan DRILL ATTACHMENT

for Synthes radiolucent drive 511.300

0 - 900 rpm; 110 x 35 mm;  225 g





**GB663R**

**GB496R**

### Acculan 4 DRILL ATTACHMENT

with trinkle AO chuck

0 - 1,000 rpm; 5.0 Nm;  4.0 mm;  
93 x 35 mm;  217 g





**GB664R**

**GB496R**

### Acculan 4 DRILL ATTACHMENT

with AESCULAP® hexagonal chuck

0 - 1,000 rpm; 5.0 Nm;  4.0 mm;  
86 x 35 mm;  225 g





**GB665R**

**GB496R**

### Acculan 4 DRILL ATTACHMENT

with Hudson / Zimmer chuck

0 - 1,000 rpm; 5.0 Nm;  4.0 mm;  
100 x 35 mm;  230 g



# AESCU LAP<sup>®</sup> Acculan 4



## ATTACHMENTS

**GB657R**

**GB496R**

### Acculan 4 INTRAMEDULLAR ATTACHMENT

with large AO chuck

0 - 370 rpm; 12.0 Nm;  4.0 mm;  
108 x 35 mm;  300 g





**GB667R**

**GB496R**

### Acculan 4 REAMER ATTACHMENT

with Jacobs chuck 0.5 - 7.4 mm chuck

0 - 250 rpm; 19.0 Nm;  4.0 mm;  
133 x 35 mm;  280 g

consisting parts:  
key GA031R





**GB668R**

**GB496R**

### Acculan 4 REAMER ATTACHMENT

with large AO chuck

0 - 250 rpm; 19.0 Nm;  4.0 mm;  
108 x 35 mm;  300 g



**GB669R**

**GB496R**

### Acculan 4 REAMER ATTACHMENT

with Hudson / Zimmer chuck

0 - 250 rpm; 19.0 Nm;  4.0 mm;  
118 x 35 mm;  300 g





**GB670R**

**GB496R**

### Acculan 4 REAMER ATTACHMENT

with Harris chuck

0 - 250 rpm; 19.0 Nm;  4.0 mm;  
106 x 35 mm;  290 g



**GB660R**

**GB496R**

**Acculan SAGITTAL SAW ATTACHMENT**

for Acculan rapid action saw blades  
with a maximum useable length of  
50 mm

↔ 0 - 17,000 rpm; ∠ 4°47';  
89 x 36 x 44 mm; 📖 270 g



**GB641R**

**GB496R**

**Acculan K-WIRE ATTACHMENT**

for K-wires from 0.6 - 4.0 mm

0 - 1,250 rpm; 93 x 36 x 137 mm;  
📖 285 g



# AESCULAP® Acculan 4

## OSCILLATING SAWS

**GA331**

**GB495R**

### Acculan 4 OSCILLATING SAW

250 W;  $\leftrightarrow$  0 - 13,000 rpm;  $\sphericalangle$  4.1°;  
211 x 177 x 55 mm;  $\updownarrow$  1,600 g

consisting parts:  
GA678 sterile funnel

Lid GA675 and NiMH battery GA676 to  
be ordered separately.

Measurements and weight are including  
battery and lid.



**GA336**

**GB498R**

### Acculan 4 OSCILLATING SAW STRAIGHT

250 W;  $\leftrightarrow$  0 - 13,000 rpm;  $\sphericalangle$  4.1°;  
290 x 55 x 84 mm;  $\updownarrow$  1,480 g

consisting parts:  
GA678 sterile funnel

Lid GA675 and NiMH battery GA676 to  
be ordered separately.

Measurements and weight are including  
battery and lid.



**GA337**

**GB498R**

### Acculan 4 OSCILLATING STERNUM SAW

250 W;  $\leftrightarrow$  0 - 13,000 rpm;  $\sphericalangle$  4.1°;  
290 x 55 x 84 mm;  $\updownarrow$  1,480 g

consisting parts:  
GA678 sterile funnel

Lid GA675 and NiMH battery GA676 to  
be ordered separately.

Measurements and weight are including  
battery and lid.



## RECIPROCATING SAW

**GA334**

**GB495R**

### Acculan 4 RECIPROCATING SAW

250 W; ↔ 0 – 15,000 rpm; ↓ 3.2 mm;  
207 x 180 x 55 mm; ⚖ 1,540 g

consisting parts:

GA678 sterile funnel

GB440215 cleaning plate

GA674890 cleaning adaptor

Lid GA675 and NiMH battery GA676 to  
be ordered separately.

Measurements and weight are including  
battery and lid.



**GB436R**

**GB686R**

### PROTECTION GUIDE

for use with GA334 and saw blade  
GC761R



# AESCULAP® Acculan 4

## DERMATOME

**GA340**

**GB498R**

### Acculan 4 DERMATOME

width keyless adjustable;  
thickness adjustable (1 / 10 mm steps);  
cutting thickness: 0.2 - 1.2 mm;  
cutting width: max. 78 mm;  
suitable blades: GB228R  
(to be ordered separately)

250 W; ↔ 0 - 6,500 rpm; ↓ 3.1 mm;  
277 x 113 x 83 mm; ⚖ 1,650 g

consisting parts:  
GA678 sterile funnel

Lid GA675 and small Li-Ion battery  
GA346 to be ordered separately.

Measurements and weight are including  
battery and lid.



**GA341**

**GB498R**

### Acculan 4 DERMATOME 0.1 MM

width keyless adjustable;  
thickness adjustable (1 / 10 mm steps);  
cutting thickness: 0.1 - 1.1 mm;  
cutting width: max. 78 mm;  
suitable blades: GB228R  
(to be ordered separately)

250 W; ↔ 0 - 6,500 rpm; ↓ 3.1 mm;  
277 x 113 x 83 mm; ⚖ 1,650 g

consisting parts:  
GA678 sterile funnel

Lid GA675 and small Li-Ion battery  
GA346 to be ordered separately.

Measurements and weight are including  
battery and lid.



**BA720R**

**GB688R**

### SKIN GRAFT MESHER

for use in combination with skin graft  
carriers BA721 (1:1.5) / BA722 (1:3) /  
BA723 (1:6)

150 x 195 x 105 mm; ⚖ 4,600 g

consisting parts:  
BA725R cutting roller  
BA726R ratchet wrench





# AESCULAP® Acculan 4

LOOK. FEEL. EXPERIENCE.

Acculan 4 small drill – the smallest member of the Acculan 4 family can be used for small fragment Osteosynthesis as well as for reamed intramedullary nailing.

ACCULAN 4

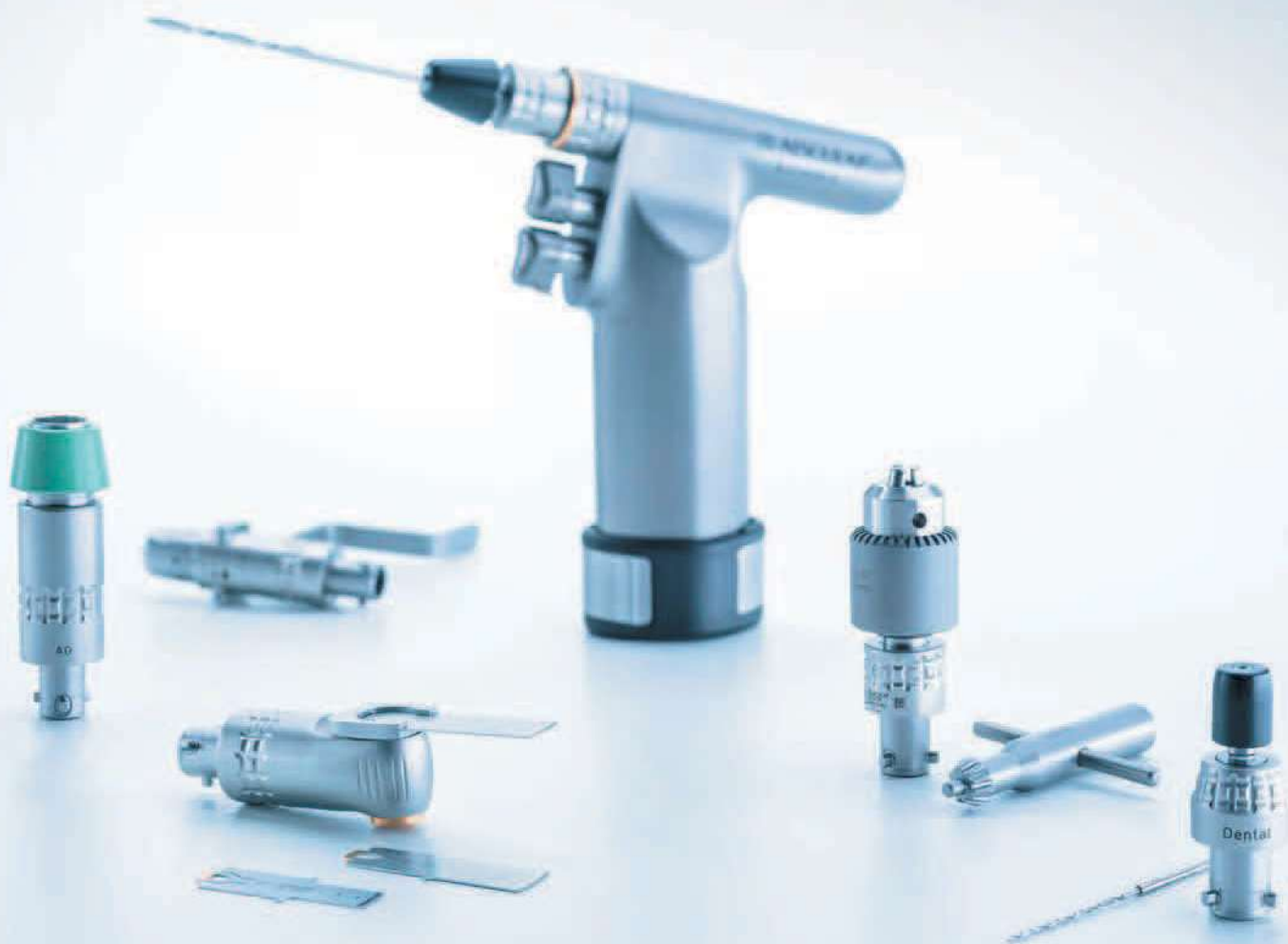

# AESCULAP® Acculan 4

## SMALL DRILL

### DRILL & ATTACHMENTS

**GA344**

**GB482R**

#### Acculan 4 SMALL DRILL

with oscillating and tapping mode;  
not for use with acetabulum reamers

85 W;  3.2 mm;  
177 x 124 x 55 mm;  840 g

consisting parts:

GA678 sterile funnel

GA344244 K-wire protection guide

GA344211 rinsing adaptor

GB600880 Sterilit spray adaptor

Lid GA675 and small Li-Ion battery  
GA346 to be ordered separately.

Measurements and weight are including  
battery and lid.



**GB870R**

**GB716R**

#### INTRAMEDULLARY REAMER ATTACHMENT

with Jacobs chuck 0.5 - 7.4 mm,  
not for use with acetabulum reamers

0 - 320 rpm; 5 Nm;  3.2 mm;  
105 x 29 mm;  230 g

consisting parts:

key GA031R



**GB871R**

**GB716R**

#### INTRAMEDULLARY REAMER ATTACHMENT

with large AO chuck,  
not for use with acetabulum reamers

0 - 320 rpm; 5 Nm;  3.2 mm;  
88 x 29 mm;  170 g





**GB872R**

**GB716R**

#### INTRAMEDULLARY REAMER ATTACHMENT

with Hudson/Zimmer chuck,  
not for use with acetabulum reamers

0 - 320 rpm; 5 Nm;  3.2 mm;  
86 x 25 mm;  150 g





## SMALL DRILL ATTACHMENTS

**GB881R**

**GB716R**

### DRILL ATTACHMENT

with Jacobs chuck 0.5 - 7.4 mm

0 - 1,250 rpm; 1.5 Nm;  3.2 mm;  
89 x 29 mm;  163 g

consisting parts:  
key GA031R





**GB882R**

**GB716R**

### DRILL ATTACHMENT

with Jacobs chuck 0.5 - 4 mm

0 - 1,250 rpm; 1.5 Nm;  3.2 mm;  
76 x 22 mm;  100 g

consisting parts:  
key GA062R





**GB884R**

**GB716R**

### DRILL ATTACHMENT

with small AO chuck

0 - 1,250 rpm; 1.5 Nm;  2.8 mm;  
60 x 22 mm;  66 g





**GB886R**

**GB716R**

### DRILL ATTACHMENT

with AESCULAP® hexagonal chuck

0 - 1,250 rpm; 1.5 Nm;  3.2 mm;  
57 x 24 mm;  67 g





**GB887R**

**GB716R**

### DRILL ATTACHMENT

with Dental shank

0 - 1,250 rpm; 1.5 Nm;  1.8 mm;  
56 x 22 mm;  50 g



# AESCU LAP<sup>®</sup> Acculan 4

## SMALL DRILL ATTACHMENTS

**GB878R**

**GB716R**

### ADAPTOR

for Synthes radiolucent drive 511.300

0 - 1,250 rpm; 1.5 Nm;  
111 x 27 mm; 181 g



**GB894R**

**GB716R**

### K-WIRE ATTACHMENT

for K-wires from 0.6 - 3.2 mm

0 - 1,250 rpm; 3.2 mm;  
92 x 27 x 124 mm; 179 g



**GB891R**

**GB716R**

### SAGITTAL SAW ATTACHMENT

for "L-sagittal" sawblades with a  
maximum usable length of 50 mm

0 - 15,750 rpm; 74 x 33.5 mm;  
4.5°; 179 g



**GB892R**

**GB716R**

### RECIPROCATING SAW ATTACHMENT

for reciprocating saw blades

0 - 15,750 rpm; 135 x 24.5 mm;  
166 g; 2.5 mm





**GB896R**

**GB716R**

**SCREW ATTACHMENT**

with small AO chuck

0 - 165 rpm; 10 Nm;  1.7 mm;  
95 x 28 x 129.5 mm;  235 g





**GB897R**

**GB716R**

**SCREW ATTACHMENT**

with AESCULAP® hexagonal chuck

0 - 165 rpm; 10 Nm;  1.7 mm;  
95 x 28 x 129.5 mm;  231 g



# AESCULAP® Acculan 4

## CHARGER & BATTERIES

### GA320

#### Acculan 4 CHARGER

for Acculan Li-Ion and NiMH batteries GA346, GA676; 4 charging bays; automatic battery diagnosis function; power cord not included

100 - 240 V AC; 50 / 60 Hz;  
410 x 120 x 160 mm; 2,300 g



### GA346

#### Acculan 4 LI-ION BATTERY SHORT

only for GA340, GA341 and GA344; with integrated electronic motor control 9.9 V; 10.89 Wh

120 x 43 x 50 mm; 265 g



### GA676

#### Acculan NIMH BATTERY

only for GA330, GA331, GA334, GA336, GA337; with integrated electronic motor control 9.6 V; 1.95 Ah

140 x 43 x 50 mm; 425 g



### GA679

### GB489R

#### Acculan BATTERY REMOVAL DEVICE



### GA675

### GB487R

#### Acculan LID

90 g



### GA678

### GB488R

#### Acculan STERILE FUNNEL





# AESCULAP® Acculan 4 Electro

LOOK. FEEL. EXPERIENCE.





## CONSOLE & BATTERIES

### GA877

Acculan Electro CONSOLE  
power cord not included  
100 - 240 V AC; 50 / 60 Hz;  
255 x 217 x 90 mm; 2,930 g

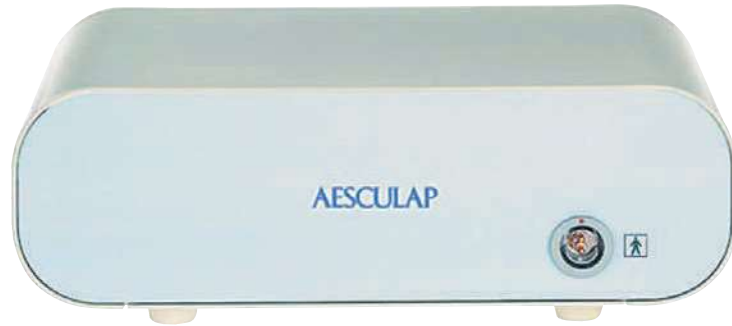

### GA878

GB486R

Acculan Electro CONNECTION CABLE  
for use with Acculan 4 handpieces  
3.0 m; 410 g



### GA875

GB485R

Acculan Electro LID



### GA876

Acculan Electro ADAPTOR  
120 x 49 x 42 mm; 165 g



### GA678

GB488R

Acculan STERILE FUNNEL



# AESCULAP® Acculan 4 ACCESSORIES

## ADAPTORS, KEYS & POWER CORD

<p><b>GB176R</b> <span style="float: right;"><b>GB467R</b></span></p> <p>ZIMMER ADAPTOR            tool: Zimmer            motor: Hudson/Zimmer            only in combination with GB630R,            GB656R, GB665R, GB669R or GB872R   3.8 mm</p>	<p><b>GB628R</b> <span style="float: right;"><b>GB690R</b></span></p> <p>SYNTHES DHS / DCS ADAPTOR            tool: Synthes DHS / DCS            motor: AO large   4.2 mm</p>	<p><b>GB184R</b> <span style="float: right;"><b>GB690R</b></span></p> <p>HARRIS ADAPTOR            tool: Harris            motor: AO large   3.5 mm</p>
		
<p><b>XF457R</b> <span style="float: right;"><b>GB690R</b></span></p> <p>DIN ADAPTOR            tool: DIN            motor: AO large   3.8 mm</p>	<p><b>GA031R</b></p> <p>KEY            for large Jacobs chuck            suitable for GB620R, GB621R,            GB667R, GB870R, GB881R</p>	<p><b>GA062R</b> <span style="float: right;"><b>GB690R</b></span></p> <p>KEY            for small 4 mm Jacobs chuck            suitable for GB639R, GB882R</p>
		
<p><b>TE780</b></p>		
<p>POWER CORD            Europe,  1.5 m</p>		
<p><b>TE730</b></p>		
<p>POWER CORD            Europe,  5.0 m</p>		
<p><b>TE734</b></p>		
<p>POWER CORD            UK,  5.0 m</p>		
<p><b>TE735</b></p>		
<p>POWER CORD            USA, Canada, Japan,  3.5 m</p>		

# AESCULAP® PROCESSING

Sterilit POWER SYSTEMS



# AESCULAP® PROCESSING

## Sterilit POWER SYSTEMS

**GB600**



Sterilit POWER SYSTEMS  
oil spray; 300 ml



**GB600850**

Sterilit POWER SYSTEMS SPRAY  
ADAPTOR

for ELAN 4 air



**GB600860**

Sterilit POWER SYSTEMS SPRAY  
ADAPTOR

for ELAN 4 electro



**GB600870**

Sterilit POWER SYSTEMS SPRAY  
ADAPTOR

for ELAN 4 MIS handpiece shafts



**GB600840**

Sterilit POWER SYSTEMS SPRAY  
ADAPTOR

for Acculan 4



**GB600880**

Sterilit POWER SYSTEMS SPRAY  
ADAPTOR

for Acculan 4 small drill and ELAN 4  
electro drill



# AESFULAP® MECHANICAL PROCESSING

- The solution for storage and mechanical reprocessing of our AESFULAP® Power Systems.
- For detailed information please refer to the Instruction for Use.



# AESULAP<sup>®</sup> MECHANICAL PROCESSING

## ECCOS SETS

### ELAN 4

#### GB261R

##### ELAN 4 electro ECCOS SET

consisting parts:

GB073R

GB076R

GB083R

GB085R

GB719R

GB072R

JF212R

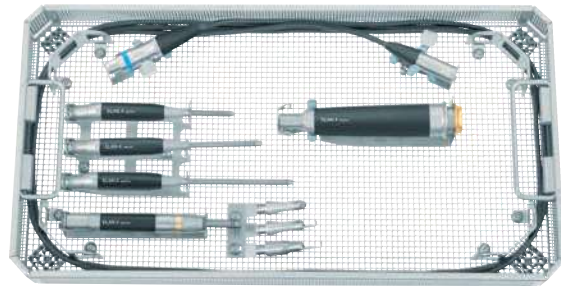

#### GB260R

##### ELAN 4 air ECCOS SET

consisting parts:

GB053R

GB056R

GB063R

GB065R

GB719R

GB072R

JF212R

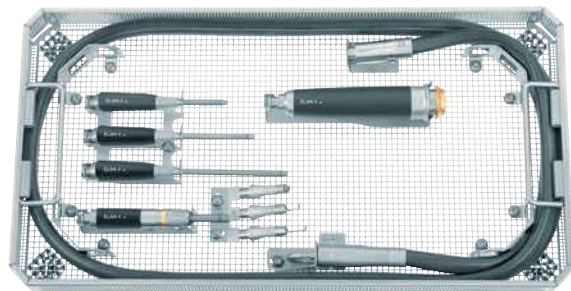

#### GB262R

##### ELAN 4 electro ECCOS SET FOR DRILL GA844

consisting parts:

GB072R

GB482R

GB715R

GB716R

JG340

JG342

JG344

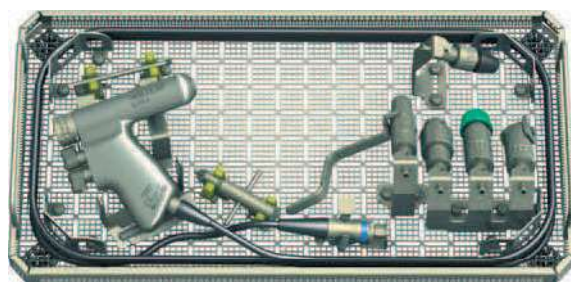

**ECCOS**  
ELAN 4 electro

<p><b>GB073R</b></p> <p><b>ECCOS HOLDER</b> for motor cable GA804, GA805, GA806 (set consisting of 2 pieces)</p>  56 mm	<p><b>GB076R</b></p> <p><b>ECCOS HOLDER</b> for perforator driver GA822</p>  56 mm	<p><b>GB077R</b></p> <p><b>ECCOS HOLDER</b> for intra motor GA824</p>  56 mm
 	 	 
<p><b>GB082R</b></p> <p><b>ECCOS HOLDER</b> for 1 handpiece</p>  56 mm	<p><b>GB083R</b></p> <p><b>ECCOS HOLDER</b> for 3 handpieces</p>  56 mm	<p><b>GB085R</b></p> <p><b>ECCOS HOLDER</b> for craniotome GA849</p>  56 mm
 	 	 
<p><b>GB086R</b></p> <p><b>ECCOS HOLDER</b> for micro sagittal saw GA836</p>  56 mm	<p><b>GB087R</b></p> <p><b>ECCOS HOLDER</b> for reciprocating saws GA832, GA837</p>  56 mm	<p><b>GB088R</b></p> <p><b>ECCOS HOLDER</b> for saws GA831, GA833</p>  56 mm
 	 	 

# AESULAP<sup>®</sup> MECHANICAL PROCESSING

ECCOS

ELAN 4 electro

GB482R	GB715R	GB716R
<p>ECCOS HOLDER for ELAN 4 electro drill GA844</p>  <p>106 mm</p>	<p>ECCOS HOLDER for 1 attachment GB870R, GB871R, GB872R, GB878R, GB881R, GB884R, GB892R, GB896R, GB897R</p>  <p>106 mm</p>	<p>ECCOS HOLDER for 3 attachments GB870R, GB871R, GB872R, GB878R, GB881R, GB884R, GB892R, GB896R, GB897R</p>  <p>106 mm</p>
	 	 



## ECCOS & RINSING DEVICES

### ELAN 4 electro

#### GB084R

##### ECCOS HOLDER

for MIS handpiece GA860



#### GB723R

##### ECCOS HOLDER

for MIS handpiece shafts GB920R - GB927R



#### GB692R

##### RINSING DEVICE

for applied parts, incl. ceramic filter GB693R  
(not suitable for autoclaving)

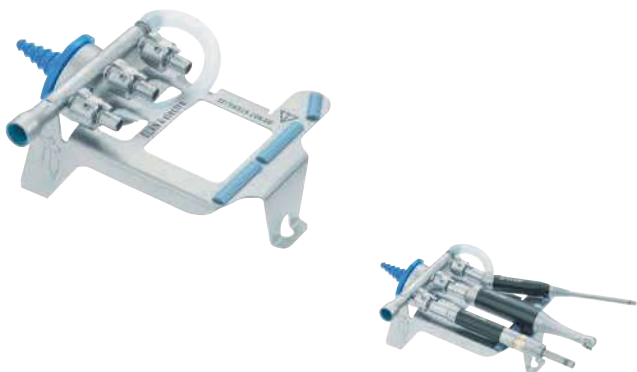

#### GB679R

##### RINSING DEVICE

for 4 MIS shafts, incl. ceramic filter GB693R  
(not suitable for autoclaving)

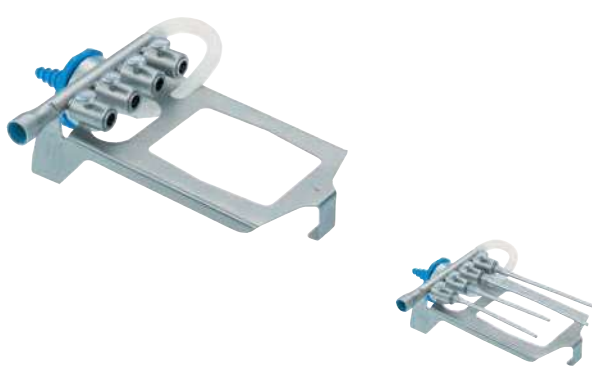

#### GB698R

##### RINSING ADAPTOR

for applied parts  
(for manual cleaning)



#### GB699R

##### RINSING ADAPTOR













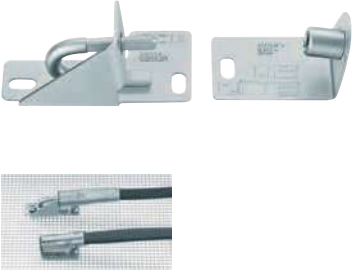
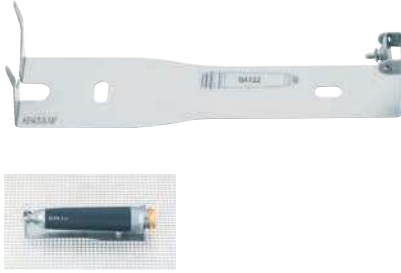

for MIS shafts  
(for manual cleaning)

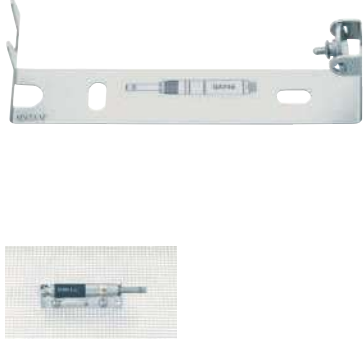

# AESCALAP<sup>®</sup> MECHANICAL PROCESSING

ECCOS

ELAN 4 air

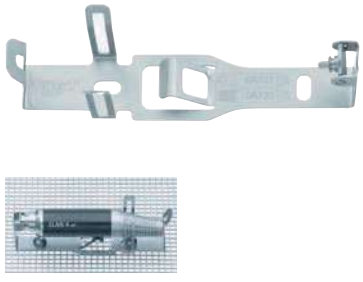
<p><b>GB053R</b></p> <p>ECCOS HOLDER for motor hose GA705R, GA706R, GA707R</p>  56 mm	<p><b>GB056R</b></p> <p>ECCOS HOLDER for perforator driver GA722</p>  56 mm	<p><b>GB057R</b></p> <p>ECCOS HOLDER for intra motor GA724</p>  56 mm
		
<p><b>GB062R</b></p> <p>ECCOS HOLDER for 1 handpiece</p>  56 mm	<p><b>GB063R</b></p> <p>ECCOS HOLDER for 3 handpieces</p>  56 mm	<p><b>GB065R</b></p> <p>ECCOS HOLDER for craniotome GA749</p>  56 mm
		
<p><b>GB066R</b></p> <p>ECCOS HOLDER for micro sagittal saw GA736</p>  56 mm	<p><b>GB067R</b></p> <p>ECCOS HOLDER for reciprocating saws GA732, GA737</p>  56 mm	<p><b>GB068R</b></p> <p>ECCOS HOLDER for saws GA731, GA733</p>  56 mm
		

## ECCOS & RINSING DEVICES

### ELAN 4 air

#### GB064R

##### ECCOS HOLDER

for MIS handpiece GA760



#### GB723R

##### ECCOS HOLDER

for 2 MIS shafts GB920R - GB927R



#### GB691R

##### RINSING DEVICE

for applied parts, incl. ceramic filter GB693R  
(not suitable for autoclaving)

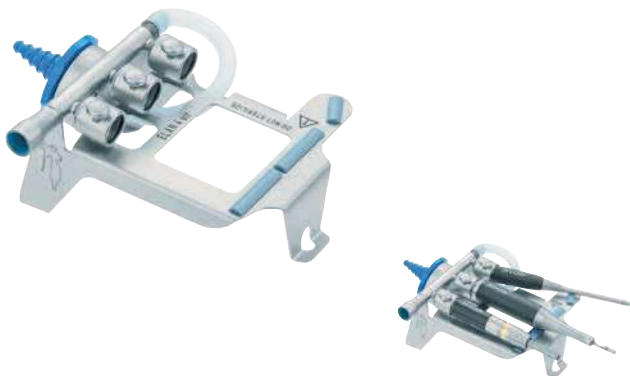

#### GB679R

##### RINSING DEVICE

for 4 MIS shafts, incl. ceramic filter GB693R  
(not suitable for autoclaving)

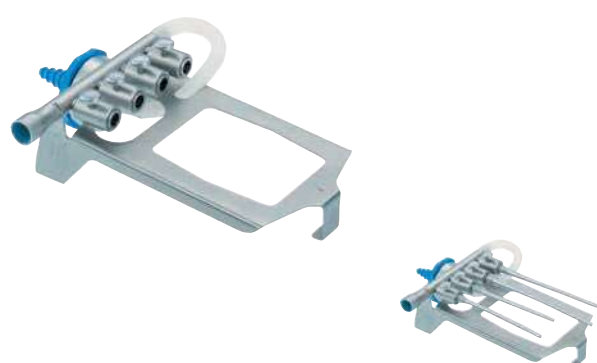

#### GB697R

##### RINSING ADAPTOR

for applied parts  
(for manual cleaning)



#### GB699R

##### RINSING ADAPTOR

















for MIS shafts  
(for manual cleaning)



# AESULAP<sup>®</sup> MECHANICAL PROCESSING

## ECCOS

### ELAN 4 ACCESSORIES

<b>GB718R</b>	<b>GB719R</b>	<b>GB720R</b>
<b>ECCOS HOLDER</b> for 12 1- and 2-ring burrs	<b>ECCOS HOLDER</b> for 3 craniotome attachments	<b>ECCOS UNIVERSAL HOLDER</b> for saw blades
 	 	 
<b>GB729R</b>	<b>GB730R</b>	<b>GB072R</b>
<b>ECCOS HOLDER</b> for 2 reciprocating saw shafts	<b>ECCOS HOLDER</b> for 2 transversal saw shafts	<b>ECCOS CABLE/HOSE POSITIONING GUIDE</b> for cable and hoses (set consisting of 4 pieces)
 	 	 
<b>GB727R</b>	<b>GB572R</b>	
<b>ECCOS HOLDER</b> for handpiece holding-sleeves GB861P, GB862P, GB863P	<b>ECCOS FIXATION</b> for GB300R - GB308R	
 	 	

## ECCOS SETS

### Acculan 4

#### GB257R

##### ECCOS SET

for Acculan 4 small drill GA344

 106 mm

consisting parts:

GB482R

GB487R

GB715R

GB716R

JG340

JG342

JG344

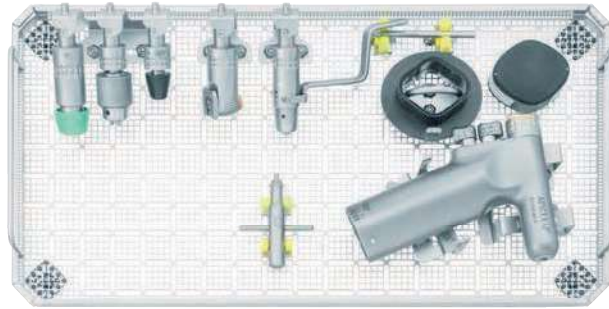

#### GB243R

##### ECCOS SET

for 2 Acculan 4 machines

 106 mm

consisting parts:

GB481R

GB487R

GB488R

GB495R

GB496R

GB497R

GB690R

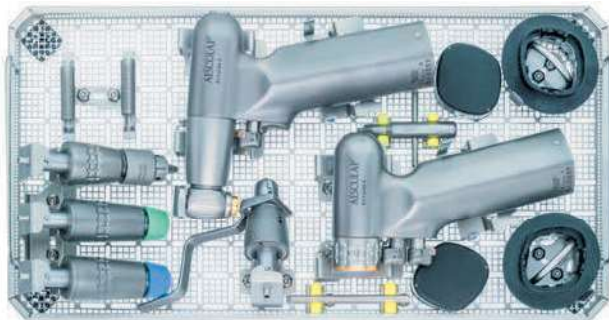

#### GB256R

##### ECCOS SET

for Acculan 4 dermatome

 106 mm

consisting parts:

GB487R

GB488R

GB498R



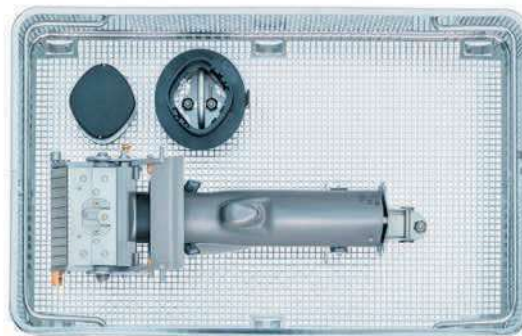















JC254R



# AESCALAP® MECHANICAL PROCESSING

## ECCOS

### Acculan 4











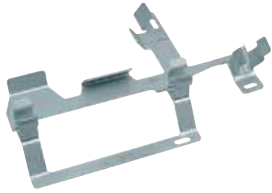

<p><b>GB482R</b></p>	<p><b>GB715R</b></p>	<p><b>GB716R</b></p>
<p>ECCOS HOLDER for Acculan 4 small drill GA344  106 mm</p>	<p>ECCOS HOLDER for 1 attachment GB870R, GB871R, GB872R, GB878R, GB881R, GB884R, GB892R, GB896R, GB897R  106 mm</p>	<p>ECCOS HOLDER for 3 attachments GB870R, GB871R, GB872R, GB878R, GB881R, GB884R, GB892R, GB896R, GB897R  106 mm</p>
		
		
<p><b>GB495R</b></p>	<p><b>GB496R</b></p>	<p><b>GB497R</b></p>
<p>ECCOS HOLDER for GA330, GA331, GA334  106 mm</p>	<p>ECCOS HOLDER for GB620R, GB621R, GB623R, GB639R, GB641R, GB645R GB660R, GB663R, GB664R, GB665R, GB657R, GB667R, GB668R, GB669R, GB670R  106 mm</p>	<p>ECCOS HOLDER for GB620R, GB621R, GB623R, GB639R, GB641R, GB645R GB660R, GB663R, GB664R, GB665R, GB657R, GB667R, GB668R, GB669R, GB670R  106 mm</p>
		
		

<p><b>GB487R</b></p>	<p><b>GB488R</b></p>	<p><b>GB489R</b></p>
<p>ECCOS HOLDER for GA675  56 mm</p>	<p>ECCOS HOLDER for GA678  76 mm</p>	<p>ECCOS HOLDER for GA679  106 mm</p>
		
		
<p><b>GB498R</b></p>	<p><b>GB686R</b></p>	
<p>ECCOS HOLDER for GA336, GA337, GA340, GA341  106 mm</p>	<p>ECCOS HOLDER for GB436R  56 mm</p>	
		
		

# AESULAP<sup>®</sup> MECHANICAL PROCESSING

## ECCOS HOLDER

Acculan 4

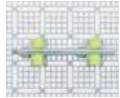
GB485R	GB486R	GB688R
<p>ECCOS HOLDER for GA875  56 mm</p>	<p>ECCOS HOLDER for GA878  56 mm</p>	<p>ECCOS HOLDER for BA720R  106 mm</p>
		
		
GB481R	GB690R	
<p>ECCOS HOLDER for saw blades and other accessories  56 mm</p>	<p>ECCOS HOLDER for keys GA672207, GA344244</p>	
 	 	



# ECCOS HOLDER

Universal Tools

GB459R	JG303R 	JG340/JG342/JG344
ECCOS® MOUNTING KIT	REPLACEMENT SCREWS-SET	SILICONE CLAMP 5 mm / 8.5 mm / 12 mm
		

# AESCALAP® POWER SYSTEMS

## TOOL ATTACHMENTS OVERVIEW

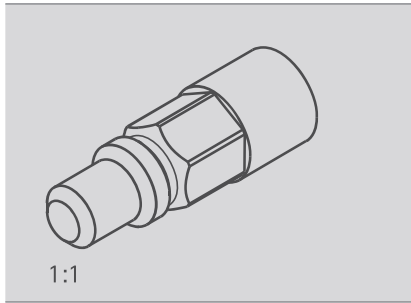

AO LARGE

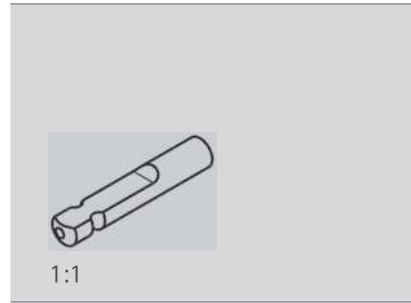

AO SMALL

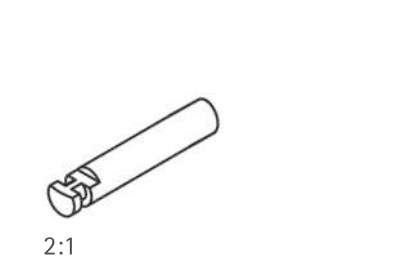

DENTAL

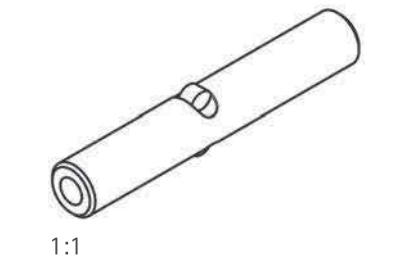

DIN

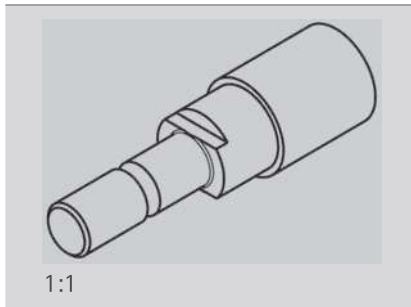

HARRIS

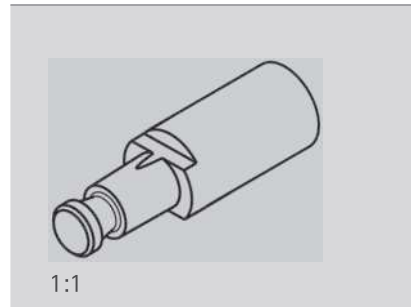

HUDSON

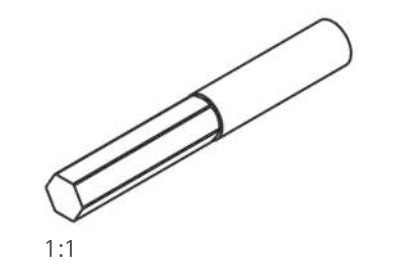

HEXAGON

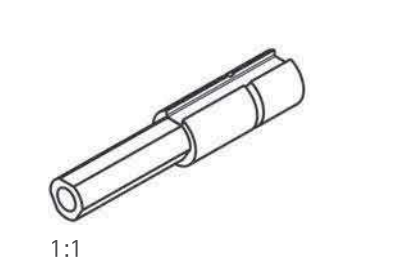

SYNTHES  
DHS/DCS

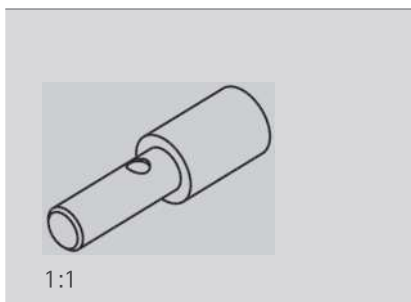



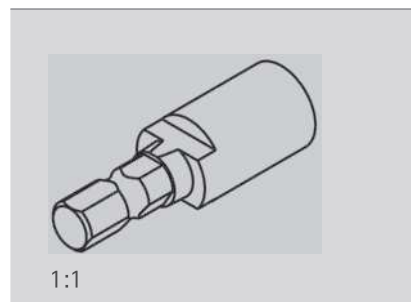











TRINKLE



ZIMMER

## SIGNS & SYMBOLS

	<b>LATEX-FREE</b> All products listed in this catalogue are latex-free
	<b>ARTICLE CODE ECCOS FIXATION</b>
	<b>FORWARD/REVERSE DRIVE</b>
	<b>FORWARD DRIVE</b>
	<b>OSCILLATION FREQUENCY</b>
	<b>OSCILLATION ANGLE</b>
	<b>STROKE</b>
	<b>CANNULATION</b>
	<b>CABLE LENGTH</b>
	<b>WEIGHT</b>
	<b>PACKAGING UNIT</b>
	<b>SINGLE USE</b>
	<b>REQUIRED HEIGHT OF TRAY</b>
	<b>STERILE</b>

# AESCULAP® POWER SYSTEMS

## BROCHURES

### Main Catalogues

#### 084002 Power Systems



#### 017599 Burrs & Blades



### ELAN 4

#### 071602 ELAN 4

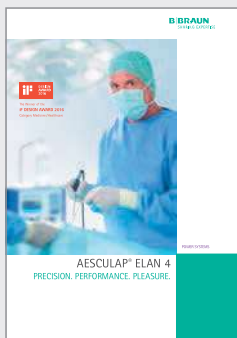

#### 071511 Mechanical Cleaning



#### 012002 Manual Cleaning

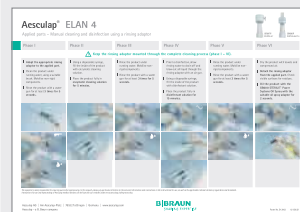

### Acculan 4

#### 001802 Acculan 4



#### 001902 Acculan 4 Dermatome

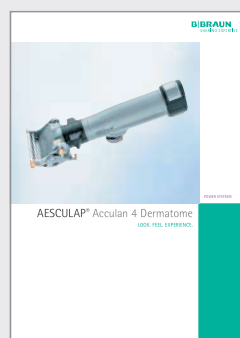

#### 002002 Acculan 4 Electro

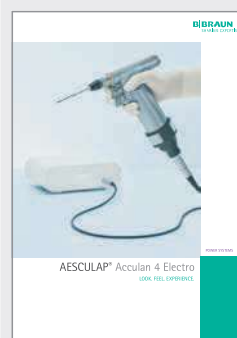

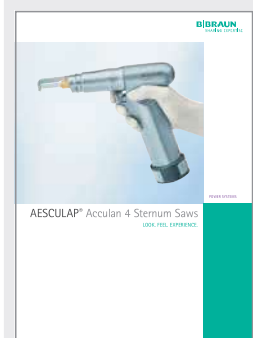

#### 002102 Acculan 4 Sternum Saws



## INDEX

Art. No.	
BA720R	40
GA031R	50
GA062R	50
GA258SU	31
GA259SU	31
GA261SU	31
GA262SU	31
GA263SU	31
GA264SU	31
GA265SU	31
GA266SU	31
GA267SU	31
GA268SU	31
GA269SU	31
GA320	46
GA330	34
GA331	38
GA334	39
GA336	38
GA337	38
GA340	40
GA341	40
GA344	42
GA346	46
GA395SU	31
GA675	46
GA676	46
GA678	46, 49
GA679	46
GA702R	21
GA703R	21
GA705R	22
GA706R	22
GA707R	22
GA708	22
GA710R	21
GA712R	21
GA713R	21
GA715R	21
GA722	22
GA724	29
GA731	29
GA732	29
GA733	29
GA736	29
GA737	29
GA749	23
GA760	27
GA761	24
GA762	24
GA763	24
GA764	24
GA765	25

Art. No.	
GA766	25
GA767	25
GA768	25
GA769	25
GA800	7
GA804	8
GA805	8
GA806	7
GA808	7
GA810	7
GA822	8
GA824	8
GA831	15
GA832	15
GA833	15
GA836	15
GA837	15
GA844	16
GA849	9
GA860	13
GA861	10
GA862	10
GA863	10
GA864	10
GA865	11
GA866	11
GA867	11
GA868	11
GA869	11
GA875	49
GA876	49
GA877	49
GA878	49
GB053R	58
GB056R	58
GB057R	58
GB062R	58
GB063R	58
GB064R	59
GB065R	58
GB066R	58
GB067R	58
GB068R	58
GB072R	60
GB073R	55
GB076R	55
GB077R	55
GB082R	55
GB083R	55
GB084R	57
GB085R	55
GB086R	55
GB087R	55

Art. No.	
GB088R	55
GB176R	50
GB184R	50
GB243R	61
GB256R	61
GB257R	61
GB260R	54
GB261R	54
GB262R	54
GB436R	39
GB459R	65
GB481R	64
GB482R	56, 62
GB485R	64
GB486R	64
GB487R	63
GB488R	63
GB489R	63
GB495R	62
GB496R	62
GB497R	62
GB498R	63
GB572R	60
GB600	52
GB600840	52
GB600850	52
GB600860	52
GB600870	52
GB600880	52
GB620R	34
GB621R	34
GB623R	34
GB628R	50
GB639R	35
GB641R	37
GB645R	35
GB657R	36
GB660R	37
GB663R	35
GB664R	35
GB665R	35
GB667R	36
GB668R	36
GB669R	36
GB670R	36
GB679R	57, 59
GB686R	63
GB688R	64
GB690R	64
GB691R	59
GB692R	57
GB697R	59
GB698R	57

Art. No.	
GB699R	57, 59
GB715R	56, 62
GB716R	56, 62
GB718R	60
GB719R	60
GB720R	60
GB723R	57, 59
GB727R	60
GB729R	60
GB730R	60
GB796SU	31
GB797SU	31
GB861P	30
GB862P	30
GB863P	30
GB866R	30
GB870R	16, 42
GB871R	16, 42
GB872R	16, 42
GB878R	16, 44
GB881R	17, 43
GB882R	17, 43
GB884R	17, 43
GB886R	17, 43
GB887R	17, 43
GB891R	18, 44
GB892R	18, 44
GB894R	18, 44
GB896R	19, 45
GB897R	19, 45
GB920R	13, 27
GB921R	13, 27
GB922R	13, 27
GB925R	13, 27
GB926R	13, 27
GB927R	13, 27
GB941R	9, 23
GB942R	9, 23
GB943R	9, 23
GB945R	9, 23
GB947R	9, 23
JG303R	65
JG340	65
JG342	65
JG344	65
TE730	30, 50
TE734	30, 50
TE735	30, 50
TE780	30, 50
XF457R	50





# AESCULAP<sup>®</sup> – a B. Braun brand

Aesculap AG | Am Aesculap-Platz | 78532 Tuttlingen | Germany  
Phone +49 7461 95-0 | Fax +49 7461 95-2600 | [www.aesculap.com](http://www.aesculap.com)

The main product trademark "Aesculap" is a registered trademark of Aesculap AG.

Subject to technical changes. All rights reserved. This brochure may only be used for the exclusive purpose of obtaining information about our products. Reproduction in any form partial or otherwise is not permitted.